

1 - 3/4" x 5" Applied Glass Stop

Scale: 1/4" = 1

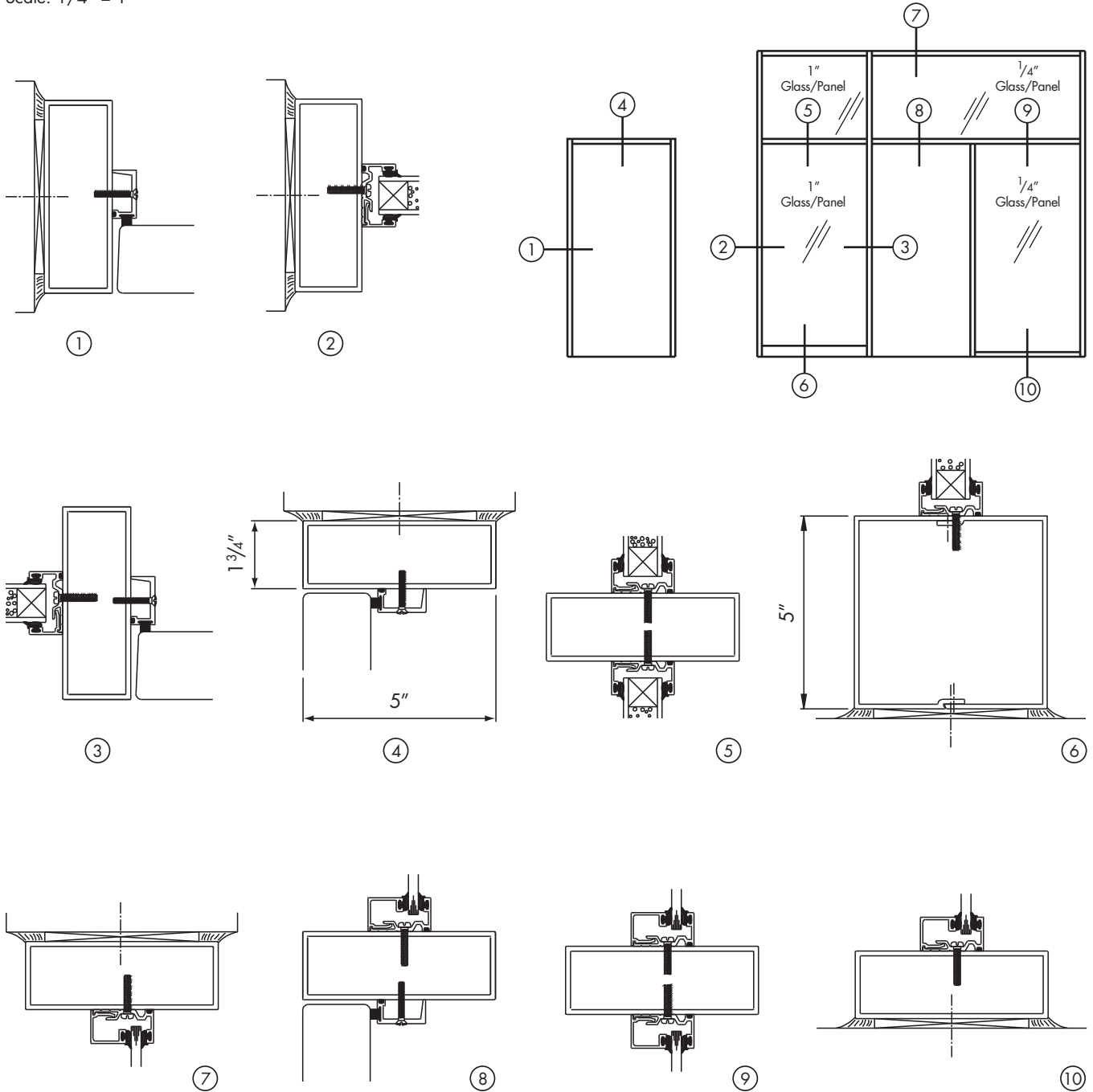

Product specifications and construction details subject to change without notification.

Special-Lite, Inc.

P.O. Box 6, Decatur, MI 49045

Ph: 800.821.6531 • Fx: 800.423.7610 • www.special-lite.com

Item #7220
3M 05/10 JBP